



Acoustic Collection

A perfect pairing
of essential design
and acoustic function
for today's modern,
open spaces.



Lumetta®



**Lumetta's
Acoustic
luminaires
offer functional
design, and
provide premium
light output and
meaningful sound
absorption.**

Acoustic Collection

Lumetta's Acoustic Lighting: Creating a More Productive Environment

Lumetta's sound dampening Acoustic Collection enhances acoustical properties while decreasing noise and vibration in open space settings.

The L2 Acoustic Series luminaires provide the functional aesthetics of a colorful inner and/or outer acoustical shade. These vibrant luminaires are constructed of felt that has been color-selected to complement our full range of Lumenate® customizable diffuser outer shades. L2 pendants can be designed with both inner and outer acoustic shades or with the pairing of an acoustic and a Lumenate® shade. Lumetta's acoustic lighting solutions offer both form and function with a variety of bold-colored, sound dampening felt shade choices to enhance your L2 Acoustic luminaire designs.

Our Lumenate® diffusers are available in vibrant colors, hues and patterns and can be customized to match your colors and display graphics. Frames are made with high-quality steel and aluminum and are finished with durable and easy-to-use low VOC powder coat paint.

Our Linear Acoustic Series includes environmentally friendly 60% recycled PET designer board fiber felt and is available in 20 standard colors. This premium material is fire resistant, with an ASTM E84 Class A rating and is proudly manufactured in the USA by our partner, Sutherland Felt Co. Fabricated with welded steel and aluminum frames and finished with your choice of our durable powder coat colors, the rectilinear felt pendants offer up and/or down lighting.

The Linear Acoustic Series includes a wall sconce that absorbs and deflects noise and echoes while adding a colorful accessory to your wall. These sconces increase comfort and concentration and create artful wall appeal.

Lumetta's Acoustic Collection is utilized in commercial and architectural environments—from business sectors such as medical, hospitality, education, government, retail, office and more.

[Read on to learn more about this dynamic collection.](#)

L2 Acoustic

The L2 Acoustic Series combines Lumetta's flair for multi-color creative expression with sound dampening features—producing a beautiful unison of exceptional design and acoustic function. Our acoustic fixtures are Sabin rated for sound absorption.

Lumetta offers an extensive range of our exclusive Lumenate®* shade patterns and colors or you can customize Lumenate® to your specific requirements. Lumenate® is available only through Lumetta.

**Lumenate®, is a flexible, washable, antimicrobial diffuser material that is exclusive to Lumetta lighting fixtures and can be fully customized to any specific color, pattern or design that you like.*

There are so many ways to express your creative vision!



Luminaire PT3225L2A shown with Lumenate® D867 Maple and Custom Acoustic shades in AC Caribbean

Lumetta's commercial lighting fixtures have been the center and focal point of many scholastic environments, due to the cohesion of their beautiful form and function.



Luminaires P51814L2A shown with Lumenate® D172 Mystic and Acoustic shade D701 AC Sunflower



Luminaire PTN3231L2A shown with Lumenate® D171 Aquamarine, Acoustic shades D702 AC Kiwi and D701 AC Sunflower

Universities have discovered Lumetta's lighting solutions are perfect to modernize and effectively illuminate their study halls, cafeterias, training centers, libraries, and other academic settings.



Luminaires P54214L2A shown with Acoustic shades D713 AC Aluminum and D703 AC Spearmint

L2 Acoustic Drums

Lumetta's world-class collection of drum pendants and surface mounts can be customized in a range of diameters, heights, and lamping options. These sleek modern fixtures are Sabin rated for sound absorption and can be fitted with any of our current or customized Lumenate® selections.



Luminaire P53414L2A shown with Lumenate® D180 Bamboo and Acoustic shade D705 AC Mango

Lumetta's Acoustic Drum Collection pairs illumination and design with sound dampening features; controlling high noise levels and vibration within office settings. Our integrated system optimizes the synergy between our handcrafted illumination and our superior acoustic products, increasing employees' satisfaction and the success of the office.



Luminaire P54214L2A shown with Lumenate® D14 Eggshell and Acoustic shade D701 AC Sunflower

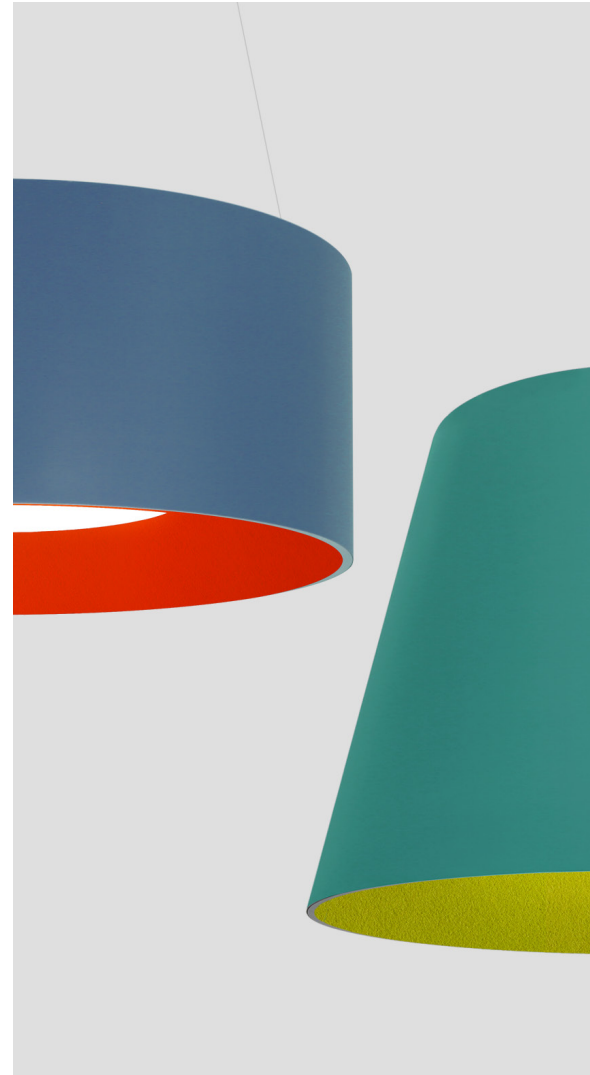

Luminaire P53414L2A shown with Custom Blue Lumenate® and Acoustic shade D707 AC Siren; Luminaire PT3225L2A shown with Lumenate® D171 Aquamarine and Acoustic shade D703 AC Spearmint



Luminaire PTN3231L2A shown with Lumenate® D166 Sunflower and Acoustic shades D703 AC Spearmint and D701 AC Sunflower

L2 Acoustic Tapers

Lumetta also offers a high-quality collection of taper pendants and surface mounts that can be customized in a range of diameters, heights, and lamping options. Sabin rated for sound absorption; these luminaires can be paired with any Lumenate® selection for a “one-of-a-kind” execution.

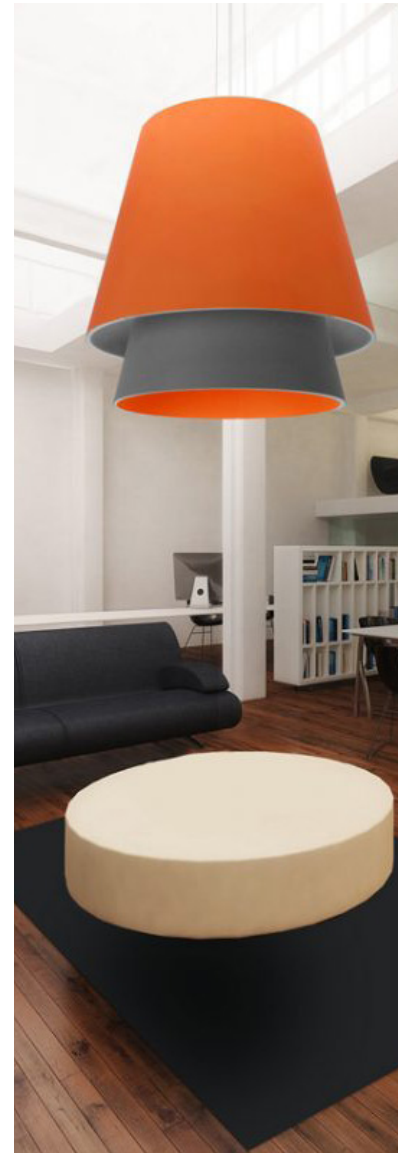

From left: Luminaire PTN3231L2A shown with Lumenate® D166 Sunflower and Acoustic shades D703 AC Spearmint and D701 AC Sunflower
Luminaire PT3225L2A shown with Lumenate® D166 Sunflower and Acoustic shades D703 AC Spearmint and D701 AC Sunflower
Luminaire P53414L2A shown with Lumenate® D166 Sunflower and Acoustic shades D703 AC Spearmint and D701 AC Sunflower

Double up on design and function.



with Acoustic shades D704 AC Orange and D715 AC Quicksilver
® D65 MT Blue and Acoustic shade D703 AC Spearmint
® D180 Bamboo and Acoustic shade D705 AC Mango



Luminaires PT1815L2A shown with Lumenate® D66 MT Bone and
Acoustic shades D711 AC Aquamarine and D707 AC Siren

L2 Acoustic Exclusive Choices

Lumetta offers 16 standard acoustic shade colors for your L2 luminaire designs.



D701 AC Sunflower



D702 AC Kiwi



D703 AC Spearmint



D704 AC Orange



D705 AC Mango



D706 AC Pink



D707 AC Siren



D708 AC Pomegranate



D709 AC Jam



D711 AC Aquamarine



D712 AC Ink

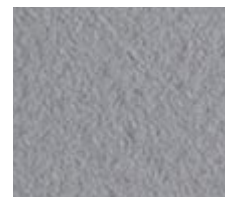

D713 AC Aluminum

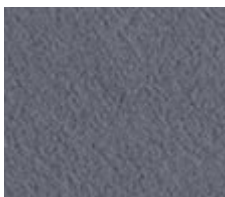

D714 AC Iron

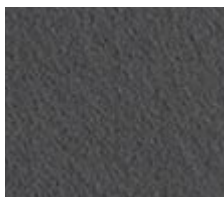

D715 AC Quicksilver

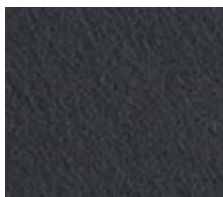

D716 AC Wheel

L2 Acoustic Drum Pendants

LED lamping comes with a white acrylic cover. Please see specification sheets for more information.

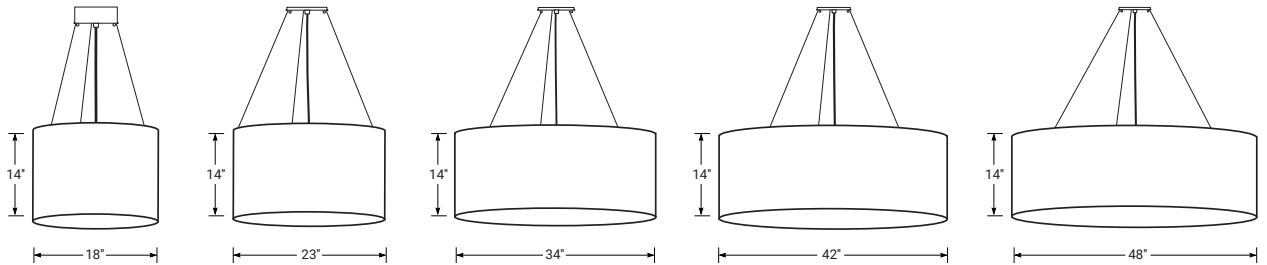

L2 Acoustic Taper Pendants

LED lamping comes with a white acrylic cover. Please see specification sheets for more information.

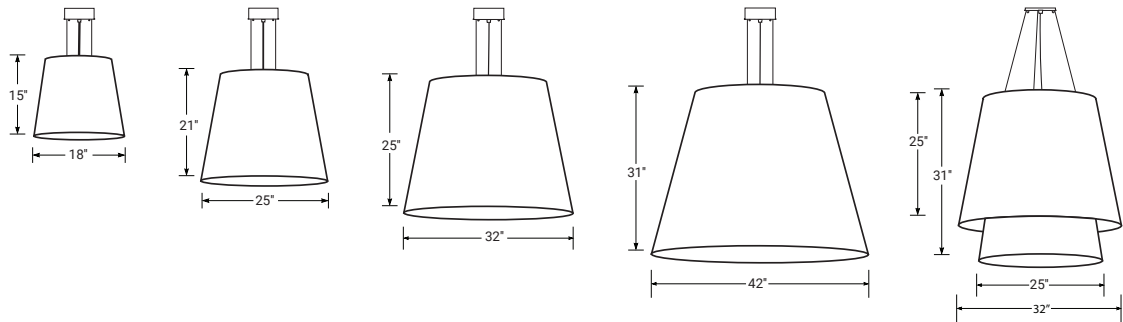

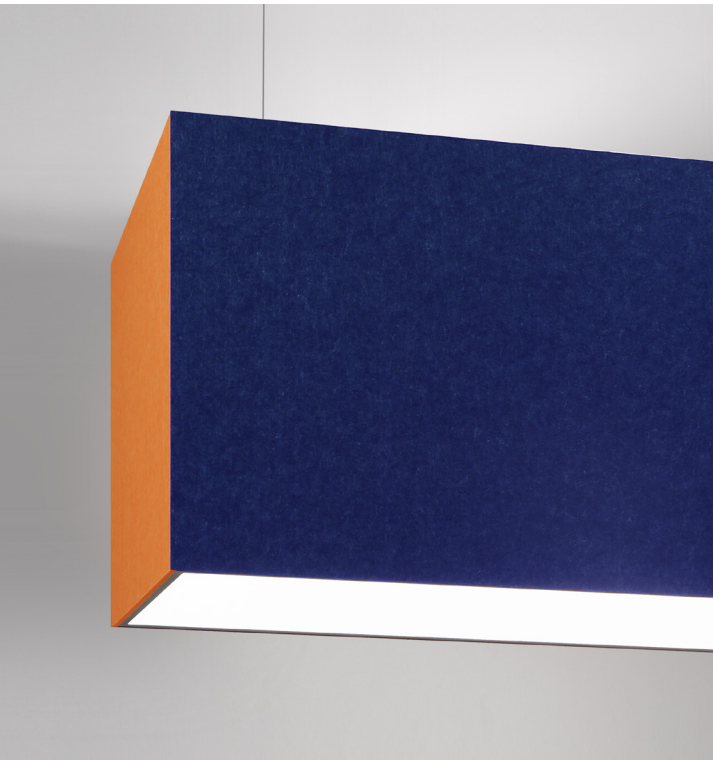

Luminaire P2448A shown with Acoustic shades D814 AC Navy and D807 AC Pumpkin

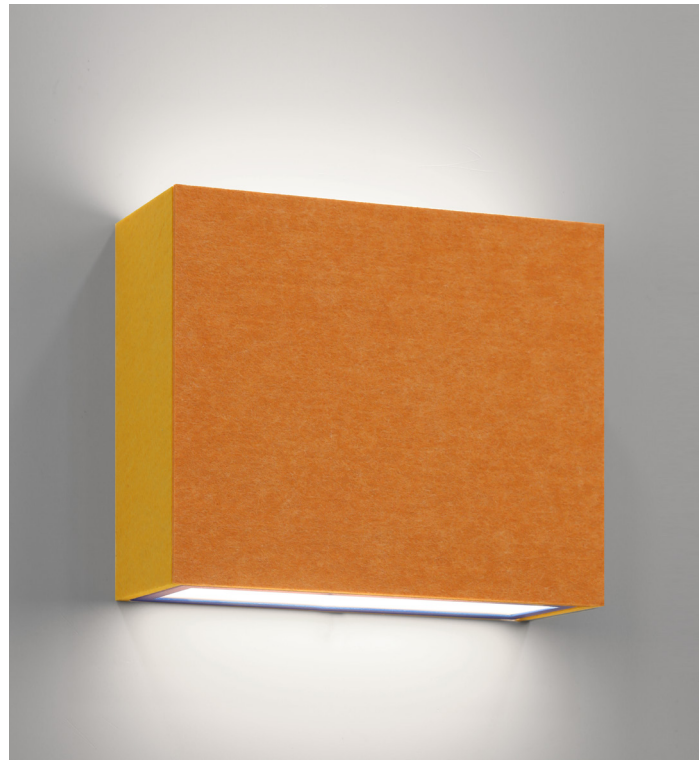

Luminaire W1210A shown with Acoustic shades D807 AC Pumpkin and D806 AC Yellow

Linear Acoustic

The Linear Acoustic Series provides a functional design with significant light output and effective sound absorption. Various sizes of rectangular luminaires will create clusters and arrays for optimal visual and acoustic comfort. Aluminum frames are surrounded with 9mm PET designer board felt and are available in any of our thirteen powder coat finishes.



Luminaires P21618A shown with Acoustic shades D819 AC Pepper, D811 AC Periwinkle, D814 AC Navy, D808 AC Halo, D802 AC Marble and D816 AC Lime

Acoustic shades are offered in two designer board felt color configurations (adjacent orientation) as well as in a single color option. Corner lap joints, accent materials, strong lines, a 9mm profile and thoughtful transitions make for a harmonious design representing Lumetta's style and artful conception.



Shown are some of our standard color options: from top left to right: Designer board felt colors D805 AC Lemon, D810 AC Purple, D815 AC Pear, D811 AC Periwinkle, D816 AC Lime, D814 AC Navy, D819 AC Pepper

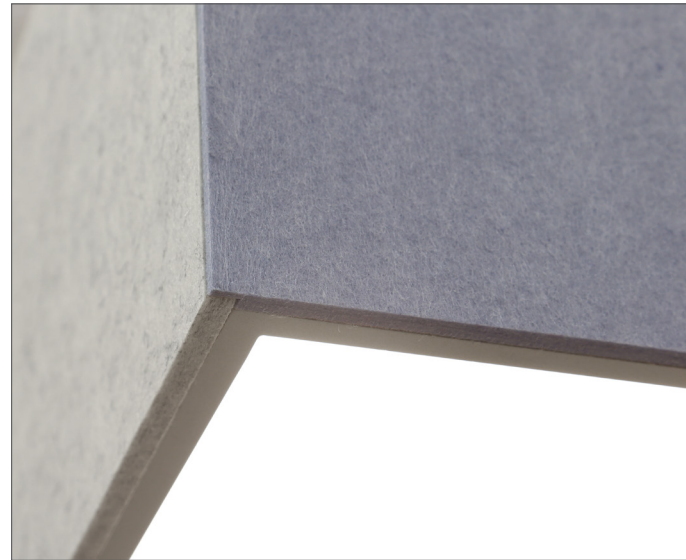

Luminaire P1248A shown with Acoustic shades D811 AC Periwinkle and D802 AC Marble



Luminaires P1440A shown with Acoustic shades D802 AC Marble and D819 AC Pepper

Streamlines & Boxes

Lumetta's Linear Acoustic Streamline and Box pendants offer modular acoustics in a simple, yet elegant contemporary design. The clean lines exemplify architectural aesthetics in commercial environments while the acoustic function limits noise distraction.

Significant light output and effective sound absorption



Luminaires P1248A shown with Acoustic shade D811 AC Periwinkle



Luminaire P1260A shown with Acoustic shades D815 AC Pear and D810 AC Purple

All Linear Acoustic pendants can be custom manufactured to fit any commercial environment. Our lighting solutions are made of the highest quality components and meet all requirements for lighting and sound standards—ensuring the most aesthetically pleasing and functional features available.



Luminaires W1210A shown with Acoustic shades D807 AC Pumpkin and D806 AC Yellow



A grouping of P4217A2 luminaires shown with Acoustic shades D803 AC Oat and D814 AC Navy

Link Acoustic

The Link Acoustic is designed so that multiple units can be joined from end-to-end, creating various lengths and compositions for every environment. Significant light output and premium sound absorption, along with independently controlled up and/or down lighting makes this a unique addition to Lumetta's Acoustic Collection.



Luminaire P4217A1 shown with Acoustic shade D807 AC Pumpkin



Luminaire P4217A3 shown with Acoustic shades D819 AC Pepper, D813 AC Sky Blue and D808 AC Halo



An interlocking array of P4217A3 luminaires shown with Acoustic shades D813 AC Sky Blue, D817 AC Heather Green and D805 AC Lemon

Linear Acoustic Exclusive Choices

Lumetta offers 20 standard designer board felt colors for your Linear Acoustic luminaire designs.

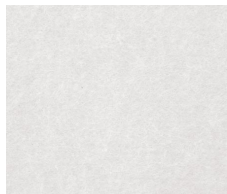

D801 AC White

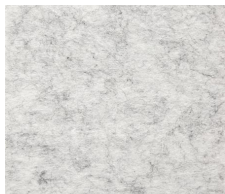

D802 AC Marble



D803 AC Oat



D804 AC Earth Brown

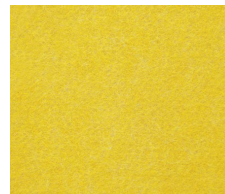

D805 AC Lemon

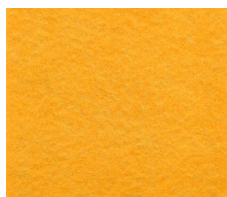

D806 AC Yellow



D807 AC Pumpkin

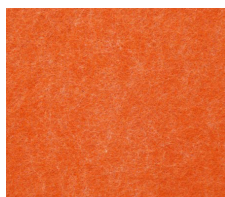

D808 AC Halo

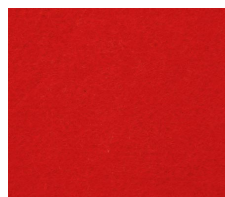

D809 AC Red



D810 AC Purple

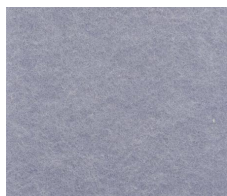

D811 AC Periwinkle



D812 AC Midnight Blue



D813 AC Sky Blue



D814 AC Navy



D815 AC Pear

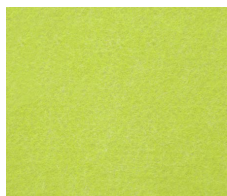

D816 AC Lime

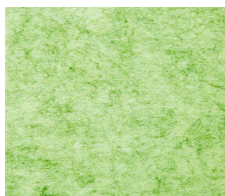

D817 AC Heather Green



D818 AC Green



D819 AC Pepper

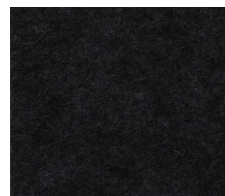

D820 AC Black

Linear Acoustic Streamline Pendants

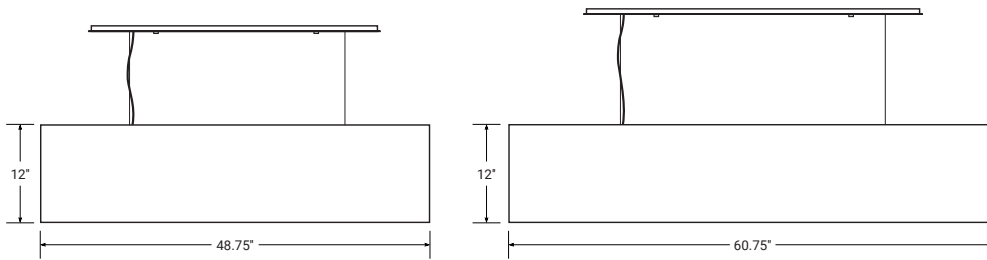

Linear Acoustic Box Pendants

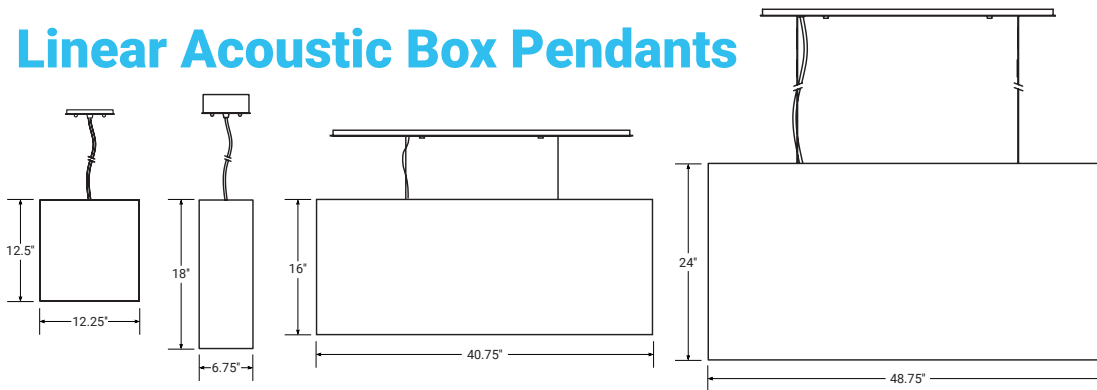

Link Acoustic Pendant

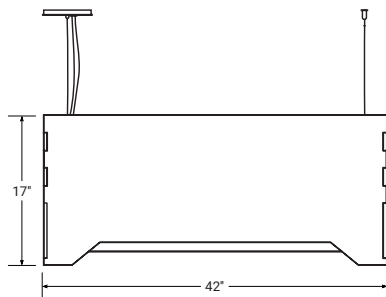

Linear Acoustic Box Sconce

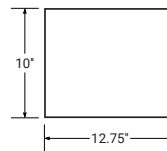

Because nothing is impossible.

Lumetta was established in 1992 and specializes in custom-designed, handcrafted, commercial lighting. The company has grown into an award-winning, national leader in the design, manufacturing, and distribution of innovative, high-quality and decorative lighting solutions for architectural and commercial applications.

We offer an unlimited range of unparalleled custom lighting for the discerning lighting designer and are committed to providing superior customer service and product performance.

Our talented lighting engineers and designers will ensure your complete satisfaction. We guarantee the best quality products and highly skilled professional services for all of your architectural and commercial lighting needs.

For more information on Lumetta's luminaire offerings:

www.lumetta.com/collections/



Luminaires P1112A shown with Acoustic shades D808 AC Halo and D807 AC Pumpkin



Luminaires P1260A shown with Acoustic shades D815 AC Pear and D810 AC Purple



For more information email info@lumetta.com